



theo

DESIGN
SIMONE BONANNI

modello registrato
registered model

portata sul piano: 150 kg
load capacity on top: 150 kg

Tavolo fisso con base composta da telaio in metallo verniciato, finitura nero opaco, sul quale sono applicati due vetri da 6 mm fusi ad alta temperatura e temperati, disponibili nelle seguenti finiture: vetro fumè e vetro bronzo con texture a righe; vetri trasparenti con texture gofrata retroverniciati nelle tinte trasparenti Ambra e Rosa Antico. Piano in vetro da 12* o 15 mm temperato, disponibile nelle seguenti varianti: vetro trasparente retroverniciato con tinte monocromatiche; vetro trasparente acidato retroverniciato con tinte metallizzate; vetro trasparente ricoperto in Ecomalta, spatolatura tipo fine.

Table with metal painted base, matt black finish, where two 6 mm thick fused and tempered glasses are placed, available in the following finishes: bronze and smoked glass with striped texture; back-painted transparent glass in amber and antique rose finishes with embossed texture. Top in 12 or 15 mm tempered glass available in: transparent back-lacquered glass with monochrome paints or transparent acid-etched and back-lacquered glass with metal paints or transparent glass handfinished with Ecomalta, finer-grained texture finish.*

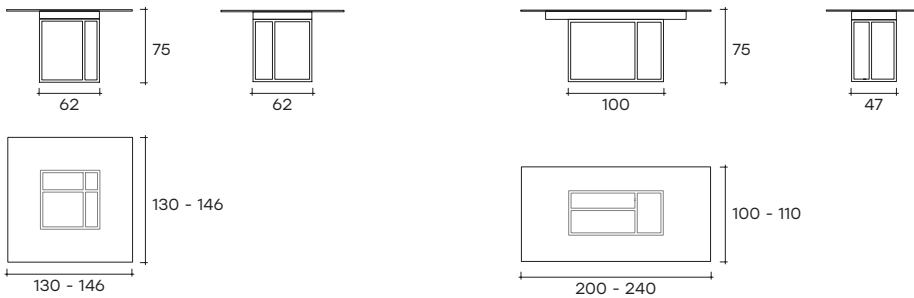

dimensioni L, P, H dimensions L, W, H (cm)	COD./CODE	L	P/W	H	peso netto net weight (kg)	peso lordo gross weight (kg)	volume imballo package volume (m³)
Tavolo con piano in vetro trasparente retroverniciato in tinta Cat.1. Base con vetri bronzo e fumè fusi con texture a righe.	*TH130-RI/V- _	130	130	75	90	138	0,85
<i>Table with top in transparent back-lacquered glass - color Cat.1. Base with fused bronze and smoked glass, with striped texture.</i>	TH146-RI/V- _	146	146	75	120	178	0,96
Tavolo con piano in vetro trasparente retroverniciato in tinta Cat.1. Base con vetri trasparenti fusi con texture gofrata e retroverniciati con tinte semi-trasparenti.	*TH200-RI/V- _	200	100	75	110	160	1,07
<i>Table with top in transparent back-lacquered glass - color Cat.1. Base with fused glass with embossed texture, back-painted.</i>	TH240-RI/V- _	240	110	75	149	211	1,07
Tavolo con piano in vetro trasparente acidato retroverniciato in tinta metallizzata Cat.2. Base con vetri bronzo e fumè fusi con texture a righe.	*TH130-RI/VA- _	130	130	75	90	138	0,85
<i>Table with top in extralight acid-etched back-lacquered glass - metallic color Cat.2. Base with fused bronze and smoked glass, with striped texture.</i>	TH146-RI/VA- _	146	146	75	120	178	0,96
	*TH200-RI /VA- _	200	100	75	110	160	1,07
	TH240-RI /VA- _	240	110	75	149	211	1,07



dimensioni L, P, H dimensions L, W, H (cm)	COD./CODE	L	P/W	H	peso netto net weight (kg)	peso lordo gross weight (kg)	volume imballo package volume (m³)
Tavolo con piano in vetro trasparente acidato retroverniciato in tinta metallizzata Cat.2. Base con vetri trasparenti fusi con texture gofrata e retroverniciati con tinte semi-trasparenti. Table with top in extralight acid-etched back-lacquered glass - metallic color Cat.2. Base with fused glass with embossed texture, back-painted.	*TH130-G/VA- _	130	130	75	90	138	0,85
	TH146-G/VA- _	146	146	75	120	178	0,96
	*TH200-G /VA- _	200	100	75	110	160	1,07
	TH240-G /VA- _	240	110	75	149	211	1,07
Tavolo con piano in vetro ricoperto in Ecomalta, spatolatura tipo fine. Base con vetri bronzo e fumè fusi con texture a righe. Table with glass top hand-finished with Ecomalta, finer-grained texture finish. Base with fused bronze and smoked glass, with striped texture.	*TH130-RI /ECO- _	130	130	75	90	138	0,85
	TH146-RI /ECO- _	146	146	75	120	178	0,96
	*TH200-RI /ECO- _	200	100	75	110	160	1,07
	TH240-RI /ECO- _	240	110	75	149	211	1,07
Tavolo con piano in vetro ricoperto in Ecomalta, spatolatura tipo fine. Base con vetri trasparenti fusi con texture gofrata e retroverniciati con tinte semi-trasparenti. Table with glass top hand-finished with Ecomalta, finer-grained texture finish. Base with fused glass with embossed texture, back-painted.	*TH130-G /ECO- _	130	130	75	90	138	0,85
	TH146-G /ECO- _	146	146	75	120	178	0,96
	*TH200-G /ECO- _	200	100	75	110	160	1,07
	TH240-G /ECO- _	240	110	75	149	211	1,07

Dimensioni su richiesta: max. 300x120 cm. Per dimensioni superiori a L. 240 cm contattare il customer service.

Custom dimensions: max. 300x120 cm. For sizes over L. 240 cm contact FIAM customer service.

VETRO RETROVERNICIATO _ BACK PAINTED GLASS			
CAT. COLORE COLOR CAT.	COLORI COLORS	CODICE _ CODE	
		Vetro trasparente Transparent glass	Vetro trasparente acidato Acid-etched transparent glass
CAT.1 Tinta unita Plain color	Grigio grafite Grey graphite	V-GR	
	Testa di moro Dark brown	V-MR	
CAT.2 Tinta metallizzata Metallic color	Marrone metallizzato Metallic brown		VA-MM
	Grigio titanio Titanium grey		VA-GT

PIANO IN ECOMALTA - ECOMALTA FINISH TOP	
FINITURE FINISHES	CODICE CODE
Tabacco Tobacco	MTA
Nero Assoluto Absolute Black	MNE



theo

extendible

DESIGN
SIMONE BONANNI

modello registrato
registered model

portata sul piano: 150 kg
portata sulla prolunga: 30 kg
load capacity on top: 150 kg
extension load capacity: 30 kg

Tavolo allungabile con base composta da telaio in metallo verniciato, finitura nero opaco, sul quale sono applicati due vetri da 6 mm fusi ad alta temperatura e temperati, disponibili nelle seguenti finiture: vetro fumè e vetro bronzo con texture a righe; vetri trasparenti con texture goffrata, retroverniciati nelle tinte trasparenti Ambra e Rosa Antico. Piano in vetro da 12* o 15 mm temperato ed allunghe in vetro da 12 mm temperato, disponibile nelle seguenti varianti: vetro trasparente retroverniciato con tinte monocromatiche; vetro trasparente acidato retroverniciato con tinte metallizzate; vetro trasparente ricoperto in Ecomalta, spatolatura tipo fine.

Extendible table with metal painted base, opaque black finish, where two 6 mm thick fused and tempered glasses are placed, available in the following finishes: bronze and smoked glass with striped texture; back-painted transparent glass in amber and antique rose finishes with embossed texture. Top in 12* or 15 mm and extensions in 12 mm tempered glass available in: transparent back-lacquered glass with monochrome paints, transparent acid-etched and back-lacquered glass with metal paints, or transparent glass hand-finished with Ecomalta, finer-grained texture finish.

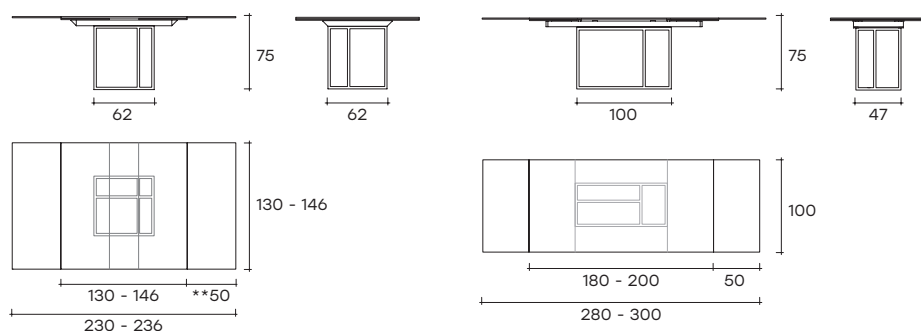

**Per tavolo con dimensione 146x146 cm, l'allungata è profonda 45 cm. _ **Extendible table 146x146 cm, extension width 45 cm.

dimensioni L, P, H dimensions L, W, H (cm)	COD./CODE	L	P/W	H	peso netto net weight (kg)	peso lordo gross weight (kg)	volume imballo package volume (m ³)
Tavolo allungabile con piano in vetro trasparente retroverniciato in tinta Cat.1. Base con vetri bronzo e fumè fusi con texture a righe . <i>Extendible table with top in transparent back-lacquered glass - color Cat.1. Base with fused bronze and smoked glass, with striped texture.</i>	*TH130AL-RI/V-_-	130 (230)	130	75	153	210	1,04
	TH146AL-RI/V-_-	146 (236)	146	75	186	269	1,36
	*TH180AL-RI/IV-_-	180 (280)	100	75	149	199	1,1
	*TH200AL-RI/IV-_-	200 (300)	100	75	155	206	1,1
Tavolo allungabile con piano in vetro trasparente retroverniciato in tinta Cat.1. Base con vetri trasparenti fusi con texture goffrata e retroverniciati con tinte semi-trasparenti. <i>Extendible table with top in transparent back-lacquered glass - color Cat.1. Base with fused glass with embossed texture, back-painted.</i>	*TH130AL-G/IV-_-	130 (230)	130	75	153	210	1,04
	TH146AL-G/IV-_-	146 (236)	146	75	186	269	1,36
	*TH180AL-G/IV-_-	180 (280)	100	75	149	199	1,1
	*TH200AL-G/IV-_-	200 (300)	100	75	155	206	1,1



dimensioni L, P, H dimensions L, W, H (cm)	COD./CODE	L	P/W	H	peso netto net weight (kg)	peso lordo gross weight (kg)	volume imballo package volume (m³)
Tavolo allungabile con piano in vetro trasparente acidato retroverniciato in tinta metallizzata Cat.2. Base con vetri bronzo e fumè fusi con texture a righe. <i>Extendible table with top in extralight acid-etched back-lacquered glass - metallic color Cat.2. Base with fused bronze and smoked glass, with striped texture.</i>	*TH130AL-RI /VA-_-	130 (230)	130	75	153	210	1,04
	TH146AL-RI /VA-_-	146 (236)	146	75	186	269	1,36
	*TH180AL-RI /VA-_-	180 (280)	100	75	149	199	1,1
	*TH200AL-RI /VA-_-	200 (300)	100	75	155	206	1,1
Tavolo allungabile con piano in vetro trasparente acidato retroverniciato in tinta metallizzata Cat.2. Base con vetri trasparenti fusi con texture goffrata e retroverniciati con tinte semi-trasparenti. <i>Extendible table with top in extralight acid-etched back-lacquered glass - metallic color Cat.2. Base with fused glass with embossed texture, back-painted.</i>	*TH130AL-G /VA-_-	130 (230)	130	75	153	210	1,04
	TH146AL-G /VA-_-	146 (236)	146	75	186	269	1,36
	*TH180AL-G /VA-_-	180 (280)	100	75	149	199	1,1
	*TH200AL-G /VA-_-	200 (300)	100	75	155	206	1,1
Tavolo allungabile con piano in vetro ricoperto in Ecomalta, spatolatura tipo fine. Base con vetri bronzo e fumè fusi con texture a righe. <i>Extendible table with glass top hand-finished with Ecomalta, finer-grained texture finish. Base with fused bronze and smoked glass, with striped texture.</i>	*TH130AL-RI /ECO-_-	130 (230)	130	75	153	210	1,04
	TH146AL-RI /ECO-_-	146 (236)	146	75	186	269	1,36
	*TH180AL-RI /ECO-_-	180 (280)	100	75	149	199	1,1
	*TH200AL-RI /ECO-_-	200 (300)	100	75	155	206	1,1
Tavolo allungabile con piano in vetro ricoperto in Ecomalta, spatolatura tipo fine. Base con vetri trasparenti fusi con texture goffrata e retroverniciati con tinte semi-trasparenti. <i>Extendible table with glass top hand-finished with Ecomalta, finer-grained texture finish. Base with fused glass with embossed texture, back-painted.</i>	*TH130AL-G /ECO-_-	130 (230)	130	75	153	210	1,04
	TH146AL-G /ECO-_-	146 (236)	146	75	186	269	1,36
	*TH180AL-G /ECO-_-	180 (280)	100	75	149	199	1,1
	*TH200AL-G /ECO-_-	200 (300)	100	75	155	206	1,1

VETRO RETROVERNICIATO _ BACK PAINTED GLASS

CAT. COLORE COLOR CAT.	COLORI COLORS	CODICE _ CODE	
		Vetro trasparente Transparent glass	Vetro trasparente acidato Acid-etched transparent glass
CAT.1 Tinta unita Plain color	Grigio grafite Grey graphite	V-GR	
	Testa di moro Dark brown	V-MR	
CAT.2 Tinta metallizzata Metallic color	Marrone metallizzato Metallic brown		VA-MM
	Grigio titanio Titanium grey		VA-GT

PIANO IN ECOMALTA - ECOMALTA FINISH TOP

FINITURE _ FINISHES	CODICE _ CODE
Tabacco _ Tobacco	MTA
Nero Assoluto Absolute Black	MNE

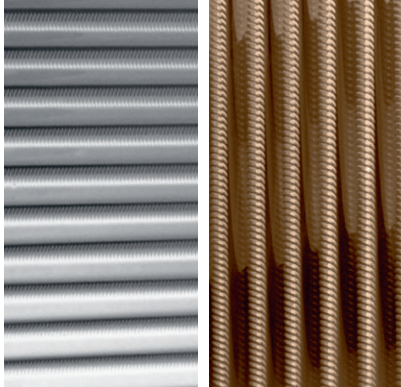

**FINITURE
FINISHES**

**Base in vetro fuso a righe
Striped fused glass base**

vetro fuso trasparente
fused transparent glass

**Base in vetro fuso goffrato
Embossed fused glass base**

ambra + rosa antico
amber + antique pink

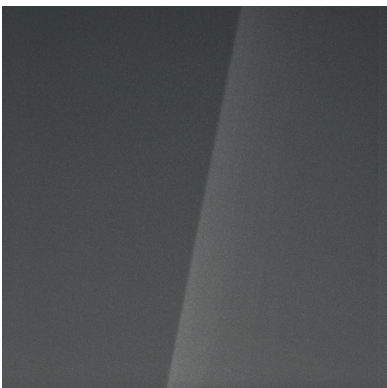
**Piano in vetro retroverniciato
Back-painted glass top**

grigio grafite
graphite grey

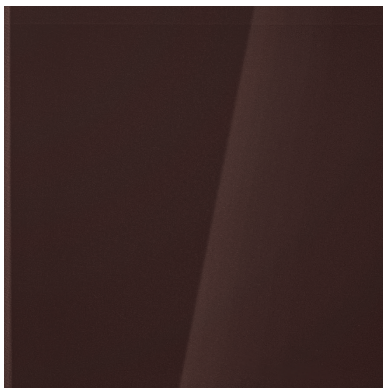

marrone testa di moro
dark brown



**FINITURE
FINISHES**

**Piano in vetro extralight acidato retroverniciato
Back-painted acid-etched extralight glass top**



marrone metallizzato
metallic brown

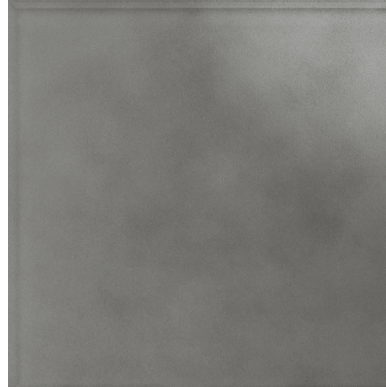

grigio titanio
titanium grey

**Piano in vetro trasparente spatolato con Ecomalta®
Transparent glass top, Ecomalta® finish**



tabacco
tobacco

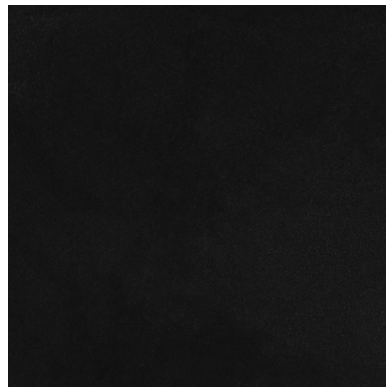

nero assoluto
absolute black